

Cleaning and Maintenance

Discover a smoking experience with Anima that meets the demands of today. Unique design and noble materials will take the whole experience to the next level.

The hookah ritual must always be finished by cleaning. It is not complicated, but you have to follow the rules. Never use aggressive chemicals or abrasives for cleaning and do not put the hookah in the dishwasher.

1 For dismantling the hookah, use the opposite procedure as when assembling it.

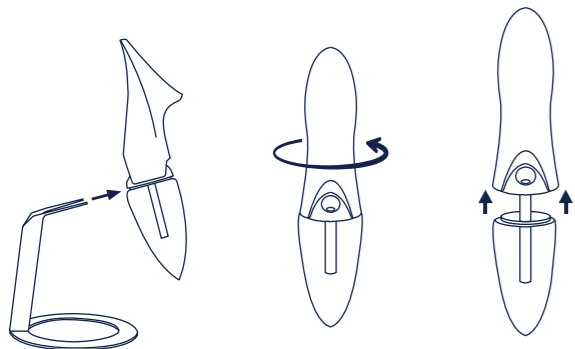

2 For dismantling the heart of the hookah, follow the next steps. Lean the downstem on a flat surface and turn it to unscrew the top of the bowl stem. Thanks to the fact that the downstem is supported by the flat surface, the heart of the hookah will be compressed and you will be able to dismantle it more easily. Then, remove the gasket under the mandrel and slide the hookah's body out of the upstem.

You can then unscrew and remove both downstem and upstem. By pulling the upstem upwards, you will remove the light module.

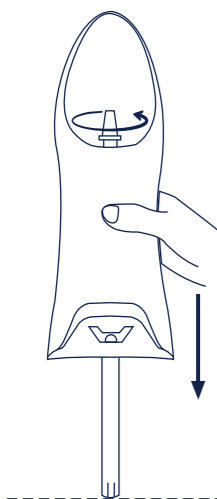

WARNING:

The light module must not come into contact with water. Otherwise, the light module will be damaged due to improper handling. When cleaning, always remove the light module from the heart of the hookah.

Light Modul

An integral part of a quality hookah experience is the atmosphere, which you can enjoy with Anima even more, thanks to the integrated light source.

Anima light offers a rainbow loop animation, you can enjoy colour transitions or choose a colour that captures your mood.

The light is powered by three easily replaceable AA batteries.

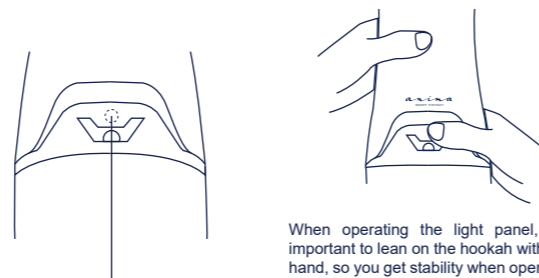

Control Button for Light Panel

When operating the light panel, it is important to lean on the hookah with your hand, so you get stability when operating. In addition, sufficient force must be used to press the control button.

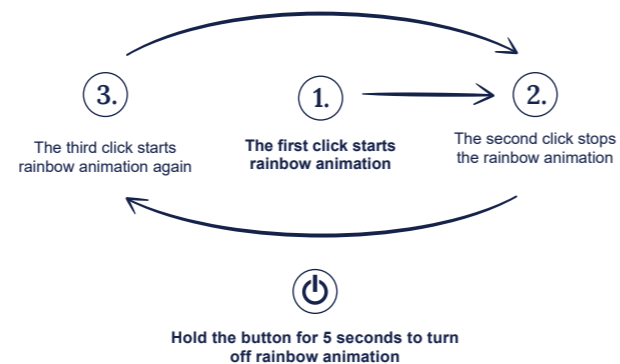

* Light Module Construction

The light module is located in the heart of the hookah, the upstem passes through it and it is securely sealed to the glass vase to prevent any damage. After removing the hookah from the heart, you can replace the batteries, check the functionality of the module or clean the hookah.

Control Button for Light Module

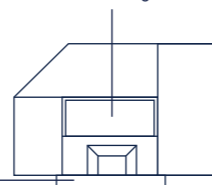

LED diodes

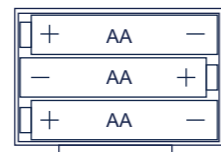

Power Supply

The light module is powered by three AA batteries. Their replacement is very simple, just remove the light module from the heart of the hookah.



WARNING:

The light module must not come into contact with water. If the light module is damaged, the hookah can still be used. Other parts of the hookah are waterproof.

Discover your Anima, the unique hookah

Anima will guide you into the world of the spiritual dimension of the contemporary smoking experience...

Anima's design is combining traditional materials and excellent function with innovative functionality and futuristic design.

We, designers, value local masters of crafts and therefore all materials and components are carefully selected and manufactured by them in the Czech Republic.

The Story Behind Anima...

Discover the story behind the brand of innovative hookahs, which inspires you to explore your soul...Anima is your soul... From the very beginning of Anima brand there was the ambition of the creators to bring to the market an innovative and modern product of the 21st century.

The Anima development team draws on many years of experience in the development of unique hookahs. And there it is. Your Anima.

Follow us

Share your hookah love #animahookah #anima



@anima.hookah.official



@animahookah

anima
SMART HOOKAH

ANIMA Hookah s.r.o
Legerova 578/70
120 00 Prague 2
Czech Republic, Europe

hello@animahookah.com
www.animahookah.com

member of hookamgnk family

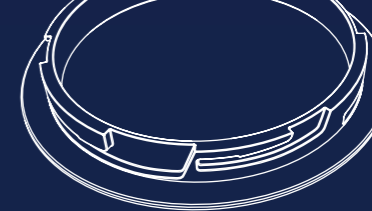

anima
SMART HOOKAH

FLOOR SOLUTION

Package Contents

You are holding a box with your Anima hookah in your hands. The box is made of high-quality sustainable materials, designed not only for safe transport to you, but also for reuse, for example when traveling. Make sure that Anima has arrived in a complete package so you can enjoy it in a few moments.

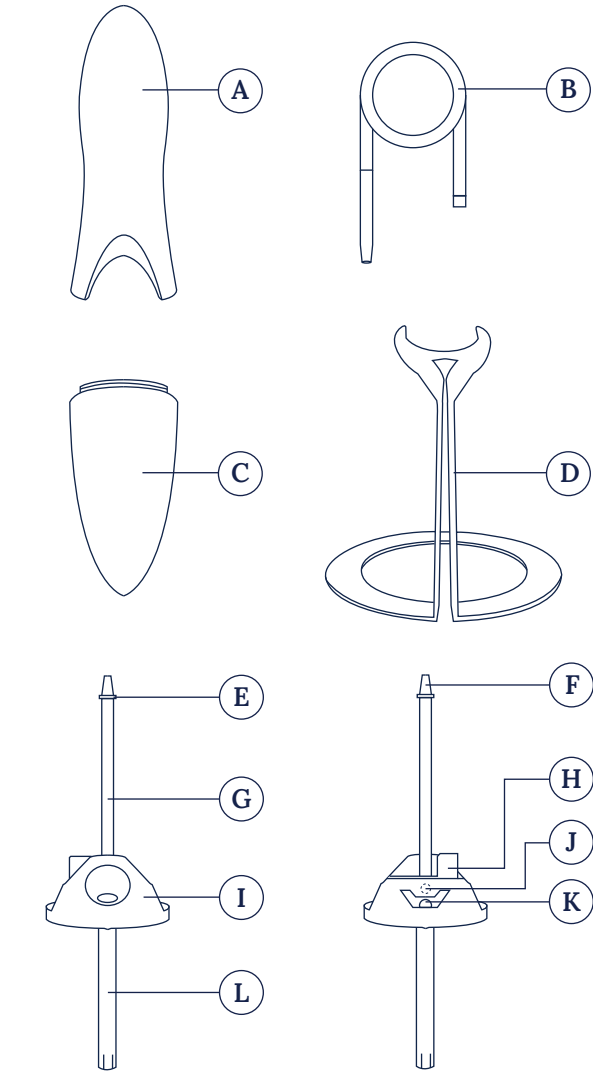

- A** Porcelain body
- B** Silicone hose
- C** Glass vase
- D** Aluminium stand
- E** Gasket
- F** Top of the bowl stem
- G** Upstem
- H** Light module
- I** Heart
- J** Light button
- K** Check valve ball
- L** Downstem

Packaging

Take a breath and get ready to unpack your Anima.

Place the box with your hookah on a flat and stable surface and open the lid carefully. Inside the box, you will find two floors of components. Remove the stand from the first floor and use the two grip holes to remove the top floor from the box. The second floor contains the remaining components of the hookah.

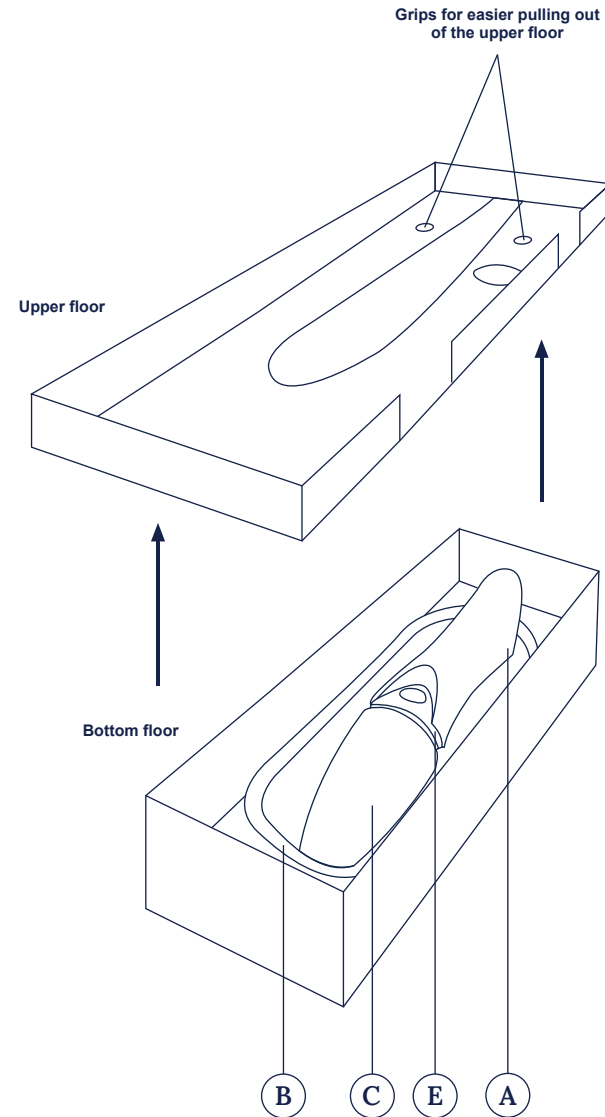

WARNING:
The box has a higher weight. Handle the hookah and its components carefully. Do not tilt the box or use more than adequate force to open it. The hookah is made of fragile materials, handle them with caution.

Basic Assembly

Below you can find the instructions for the assembly of the Anima without preparation for smoking as such. To prepare for a smoking session, we recommend following your favourite rules. Before first use, insert three AAA batteries into the light module. If the light effects do not work after completing the Anima, check the battery status – see the "Light Module" section for more information.

- 1 Hold the folded body of the vase firmly in both hands. Turn it to the left to release the glass vase from the porcelain body of the hookah.

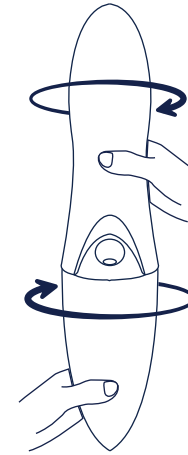

- 2 Slide the porcelain body carefully together with the heart and downstem out of the glass vase.

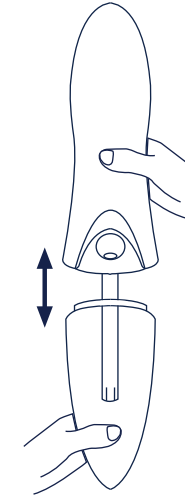

- 3 Place the stand on the lower lock of the bayonet, which is part of the neck of the glass vase. Make sure you actually hit the bottom lock.

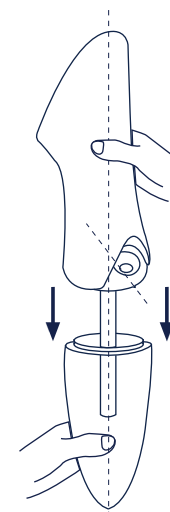

- 4 This is the location of the stand on the lower bayonet lock. The bayonet has two locks, the lower for the stand and the upper for the porcelain body.

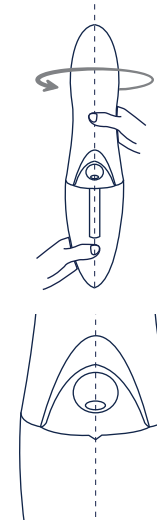

- 5 Place the assembled body and heart of the pipe on the upper lock of the bayonet on the glass vase. When placed correctly, the tab on the heart of the hookah (see the detail) should be offset from the central axis of the vase and stand.

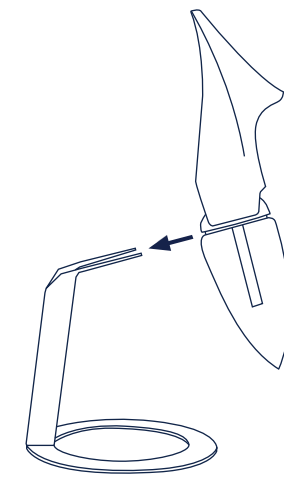

- 6 Place the assembled body and heart of the pipe on the upper lock of the bayonet on the glass vase. When placed correctly, the tab on the heart of the hookah (see the detail) should be offset from the central axis of the vase and stand.

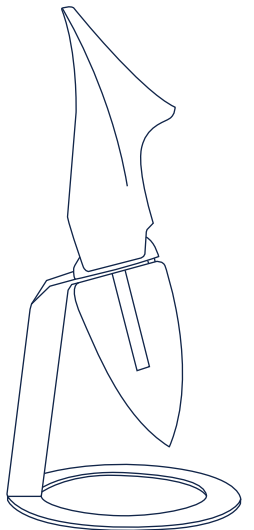

- 7 Insert the bowl (not included in the package) through the gasket on the top of the bowl stem and insert the hose into the circular hole of the heart of the hookah.

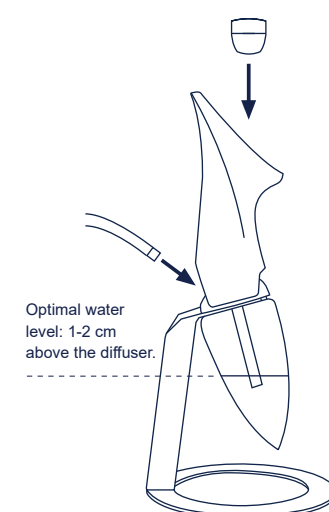

- ? **How does the hookah work?**
Air flow inside the hookah and check valve function.

